

OBS. PENTRU VARIANTA C.I.P. P23881-000 SE ÎNTRUCE IC3 2716

SCHEMĂ ELECTRICALĂ AUTOMAT PROGRAMABIL PENTRU INSTRUIRE - CIP

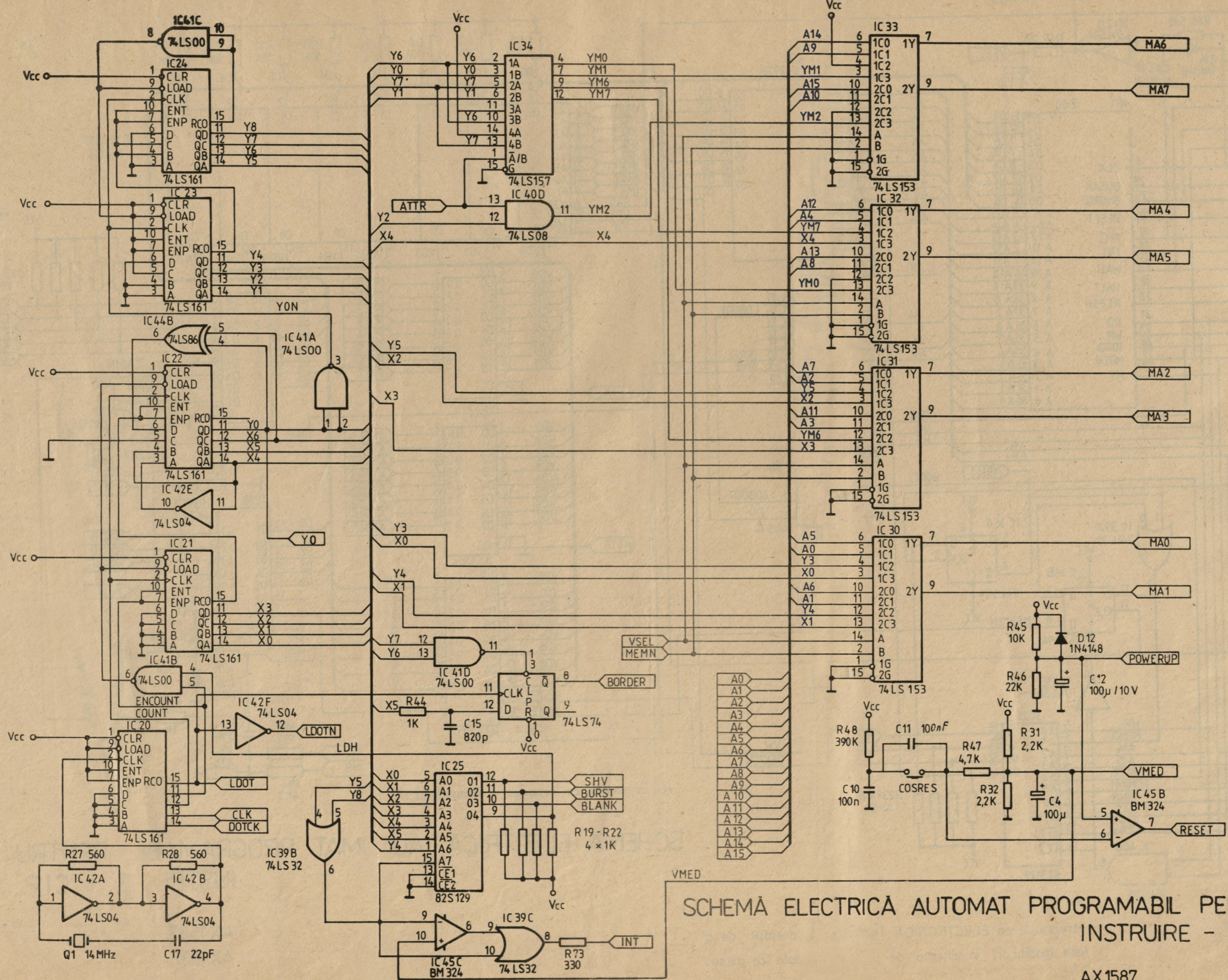

SCHEMĂ ELECTRICĂ AUTOMAT PROGRAMABIL PENTRU INSTRUIRE - CIP

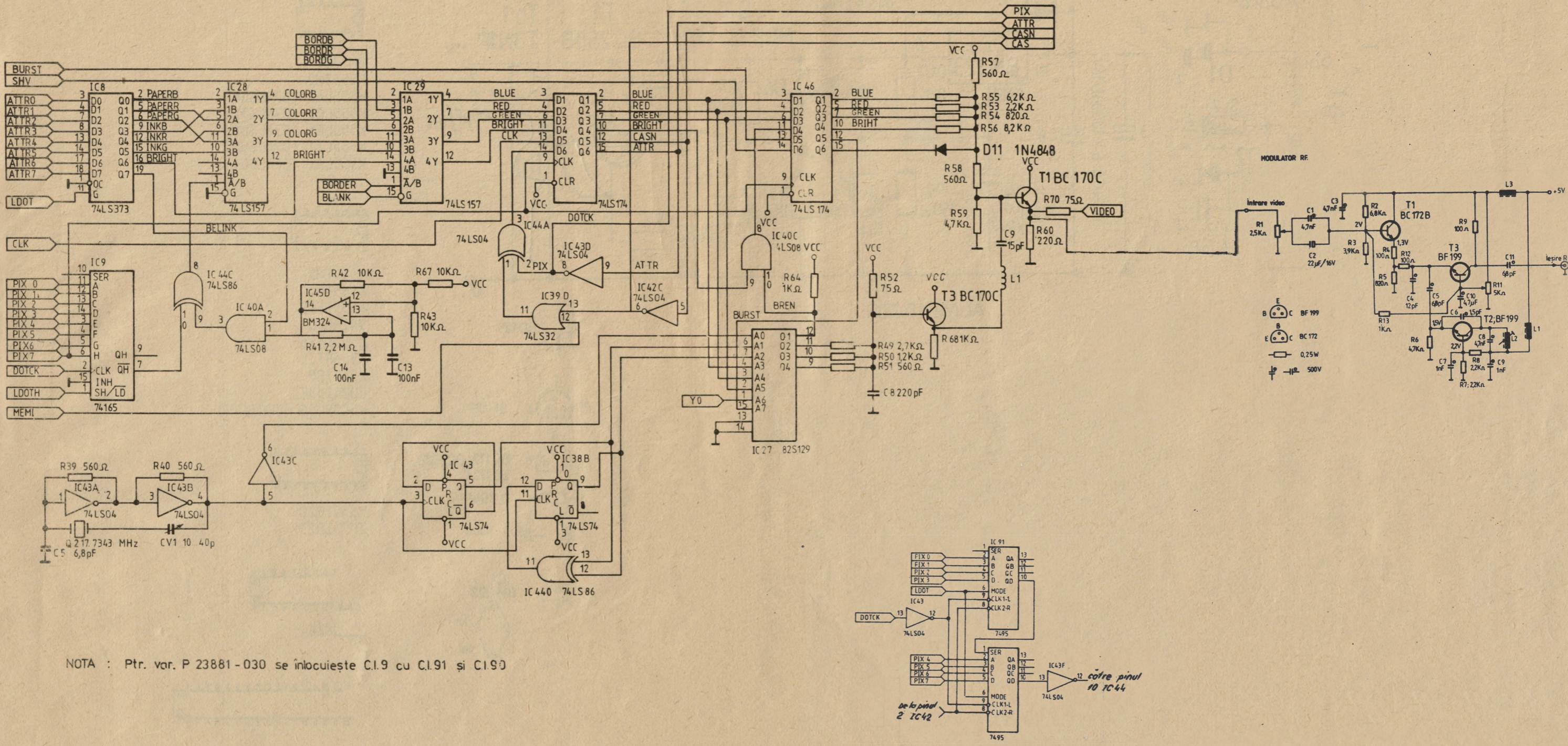

NOTA : Ptr. var. P 23881 - 030 se înlocuiește C.I.9 cu C.I.91 și C.I.93

SCHEMĂ ELECTRICĂ AUTOMAT PROGRAMABIL PENTRU INSTRUIRE - C I P

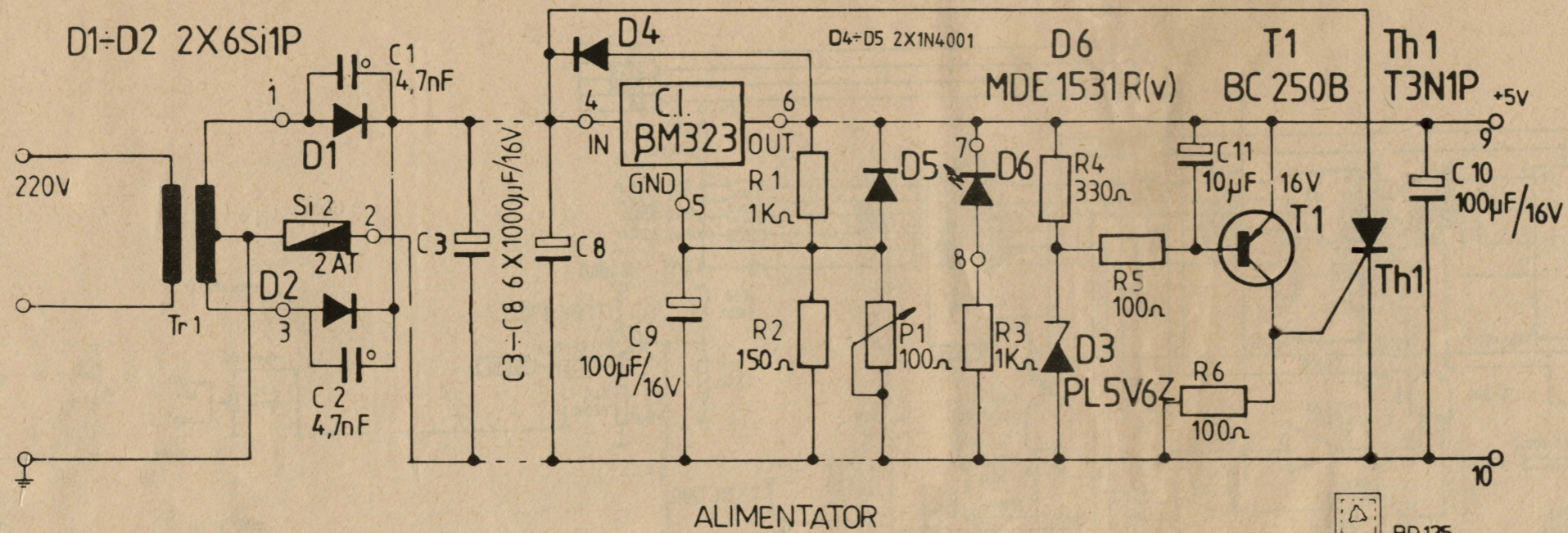

ALIMENTATOR

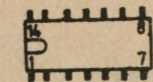

- BM 324
- K555TM2
- K555LA3 (B74LS00)
- K555LL1 (B74LS32)
- K555LP5 (B74LS86)
- K555LI1 (B74LS08)
- K555LN1 (B74LS04)

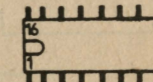

- K555TM9
- K555ID7
- K555IE10
- 74161PC
- K555KP16
- K556RT11
- K555IR9
- CDB4153E
- K565RU5G (CM8164R)

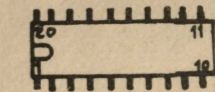
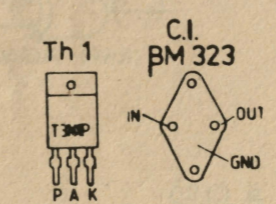
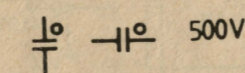
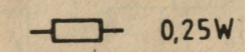
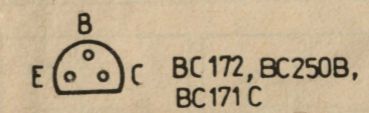
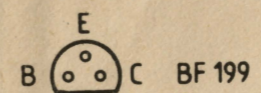
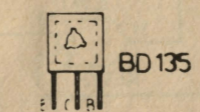

- K555IR22
- K555IR23

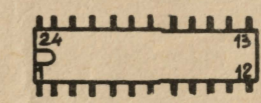

MMN2616

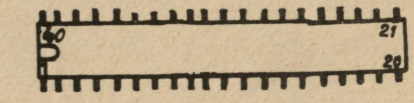

MMN80-CPU (Z80-CPU)

SCHEMĂ ELECTRICALĂ AUTOMAT PROGRAMABIL PENTRU INSTRUIRE - C I P